

Specification

June 2022

Product: TFT LCD Display

APT Model: P860ML

Client Model:



Content

1.	Product model.....	2
2.	Suppliers.....	2
3.	Specifications.....	2
4.	Dimensions and Material.....	2
5.	Features.....	3
6.	Main page.....	4
7.	Functional Description.....	5
7.1	Power On/Off.....	5
7.2	Assist level.....	5
7.3	Speed & Mileage mode.....	5
7.4	Headlight / Display Mode/ Light Sensor.....	6
7.5	Walking mode (6km).....	6
7.6	Data cleanup.....	6
7.7	USB charging port.....	7
8.	Menu Page.....	7
8.1	Display settings.....	7
8.2.1	Language.....	8
8.2.2	System.....	8
8.2.3	Brightness.....	9
8.2.4	Auto off.....	9
8.2.5	USB Port.....	10
8.2.6	Clock.....	10
8.2	E-bike Settings.....	11
8.3.1	Start password.....	12
8.3.2	Assist levels.....	13
8.3.3	Wheel.....	13
8.3.4	Battery.....	14
8.3.5	Battery Ind.....	14
8.3.6	Pow Ind.....	15
8.3.7	Light sensor.....	16
8.3	Advanced setting.....	16
8.4	Factory Setting.....	16
8.5	Information.....	17
8.5.1	Product Information.....	17
8.5.2	Battery Information.....	18
9.	Errors code.....	18
10.	Assembly instructions.....	19
11.	Install and use precautions.....	19
12.	Copyright Notice.....	错误! 未定义书签。

1. Product model

Model: 860CM

2. Suppliers

APT (Tianjin) Development Co., Ltd.

3. Specifications

- 3.5inch TFT screen(IPS)
- Wide-voltage range: 24~70V(optional)
- Multi-language support (5 languages)
- Light Sensor
- USB Type-C interface, DC 5V 500mA
- Rated operating current : 40mA, Maximum output current to controller: 200mA、off-leakage current <math>< 1\mu\text{A}</math>
- Operating temperature : -20~70°C、 Storage temperature -30~80°C
- IP65
- EN15194/2017
- RoHS

4. Dimensions and Material

Shell and bracket is made with ABS+ PC, panel is tempered glass.

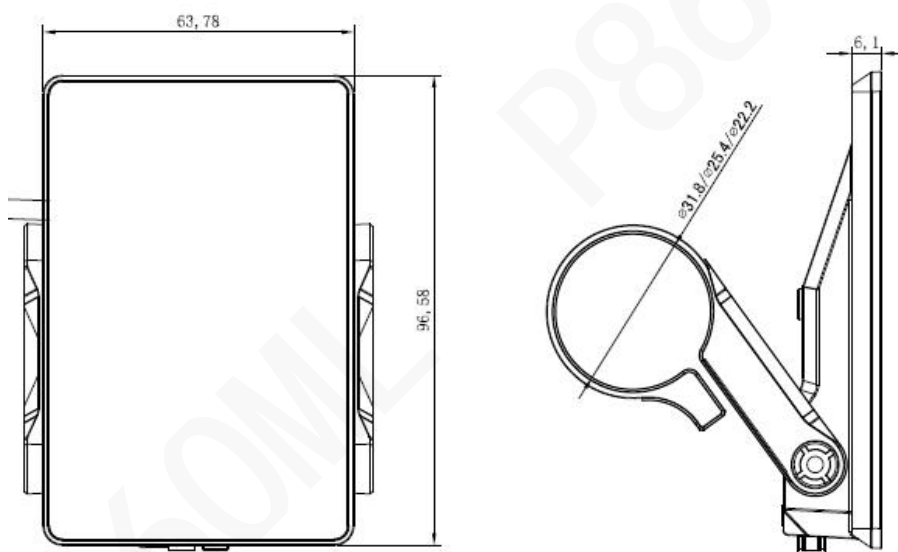

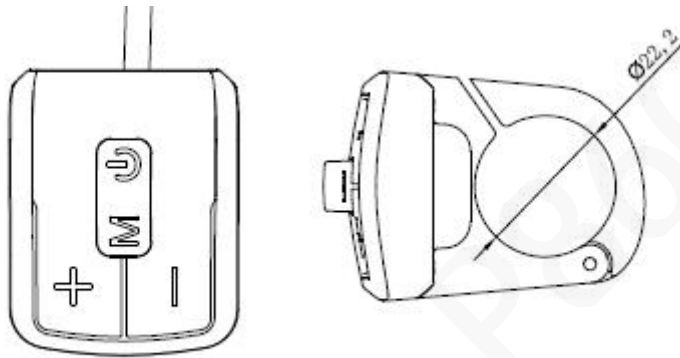



5. Features

- **3.5inch TFT screen (IPS)**
- **5 languages:**
German, French, English, Italian, Spanish are supported.
- **USB charging port: 5V 500mA**
- **Light Sensor**
- **Independent button, easy to operate**
- **Speed indicator:** Speed (Real-time), AVG Speed, MAX Speed
- **Metric / Imperial**
- **Smart battery indicator:** Capacity (percentage) or Voltage
- **Mileage indicator:** Odometer, Trip distance
- **Clock indicator:** Built in battery, clock keeps running when power off
- **Brightness setting:** Day and Night Brightness can be set independent
- **9-level Assist:** 3-level/5-level/9-level/UBE optional.
- **Power/ Current indicator:** Real-time Power(W) or Current(A).
- **Errors Code tips**
- **6km walking**
- **Firmware upgrade:** Upgrade the Logo individually

6. Main page



- **Clock:** 24hour clock
- **Head Light:** Head Light on/ off.
- **Power:** Real-time Power or Current.
- **Speed/Mileage Mode:** AVG Speed, MAX Speed, Odometer, Trip distance
- **Smart battery Power indicator:** Provide a reliable battery Power indicator.
- **Brake:** Show  when braking.
- **Assistant Level:** 4 modes optional (3/5/9/UBE)
- **Speed Value:** Real-time Speed, Km/h or MPH.
- **Maintenance Icon:** When Odometer reached presetting (Default 5000KM),  will be showed, reminding maintenance. This function is reserved and inactivated by default.
- **Errors Code:** Show  when checking errors.
- **LOGO**

7. Functional Description

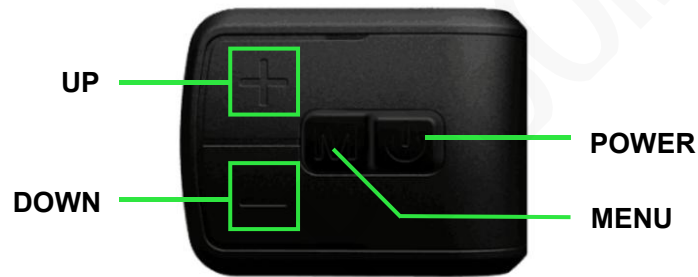

7.1 Power On/Off

Pressing **POWER** button for 2 seconds, you can turn on/off the display. The Display can automatically turn off when there is no operating & riding for 5 minutes. (Length of time can be set, refer to 8.1.4 'Auto Power off Setting')

*Input pattern in first if pattern unlock was activated.

*Display will be locked for 60 seconds after 3 times failed attempt.

7.2 Assist level

Press **UP/DOWN** button to change assist level, Top assist level is 9, 0 for neutral. Level quantities can be adjusted according to the customer requirements.

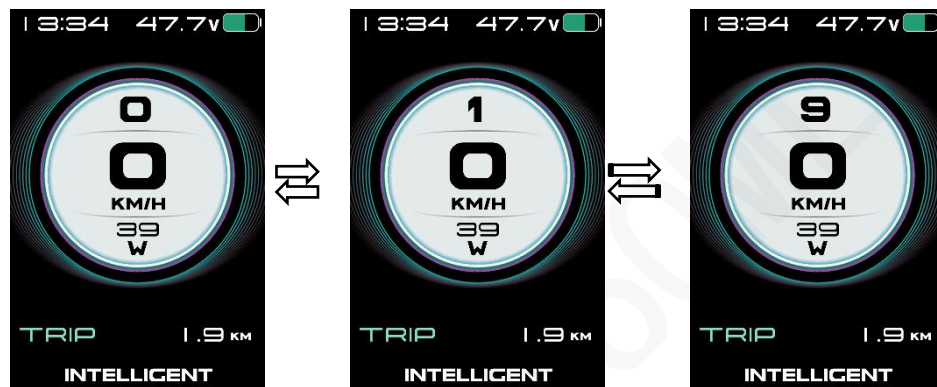

Assist level

7.3 Speed & Mileage mode

Click **MENU** button can change items on Main Page, sequence as below:
TRIP → TIME → ODO → AVG Speed → MAX Speed → RANGE



速度模式及里程模式切换显示界面

Speed/Mileage Mode

* If there is no operation for 5 seconds, right item will restore to Time automatically.

7.4 Headlight / Display Mode/ Light Sensor

Press and hold **UP** button for 2 seconds can turn on/off headlight, display will switch to the corresponding mode (Day or Night).

Build in light sensor can turn on/off headlight automatically according to external brightness.

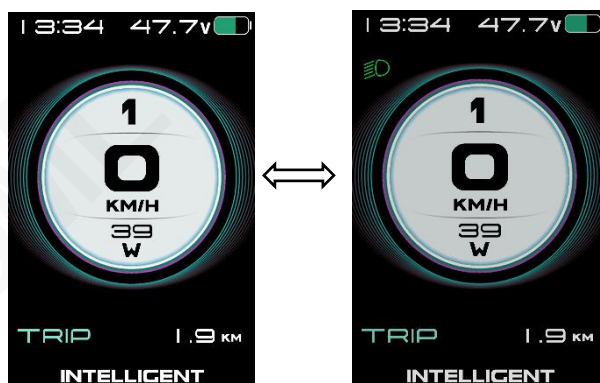

* Light sensor's sensitivity can be customized. Refer 8.1.3 Bright Setting.

* The motor does not work when the battery voltage is low, Display still can keep the headlight on for a while when E-bike is in riding.

* If you operated headlight through button, light sensor will be deactivated until reboot.

7.5 Walking mode (6km)

Press and hold **Minus** button for 2 seconds can get into walking mode, show 'P' on screen, out of walking mode when releasing button.

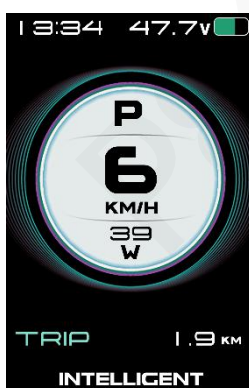

Walking Mode

7.6 Data cleanup

Press and hold **UP** & **DOWN** button together for 1 second can clean temporary

data (TRIP, Riding-Time, AVG SPD, MAX SPD data).

* Temporary data is automatically saved when power off. Abnormal power outage will cause data lost.

* Restore Factory Mode (advanced settings in Menu Page) can clear temporary data (TRIP, Riding-Time, AVG SPD, MAX SPD, Kcal, Chart data, MENU settings) except ODO.

* ODO will reset to zero over 99999km. TRIP will reset to zero over 9999.9km.

7.7 USB charging port

Set USB port on/off. USB provides charging for mobile devices, DC 5V 500mA.

8. Menu Page

Double press **MENU** button (press interval less than 0.3 second) can get into setting menus, press **UP/DOWN** button to change the parameter setting, press **MENU** button can switch to next item. Double press **MENU** button will exit from menu.

* Display will automatically quit menu if there is no operation for 30 seconds.

* For safety reason, display will be locked on Main Page when riding (speed ≥ 2 km/h), function of MENU will be deactivated.

* Display didn't save setting until click OK to confirm.

* Display doesn't quit MENU through pressing **MENU** button.

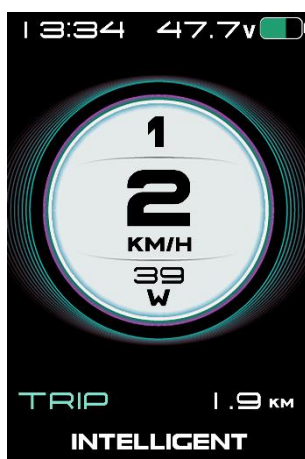

Main Page

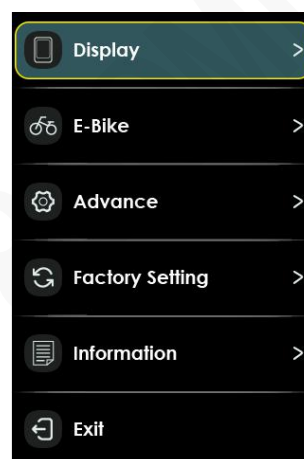

Menu Page

8.1 Display settings

Display settings include several items: Language, System, Brightness, Auto off, USB Port, Clock.

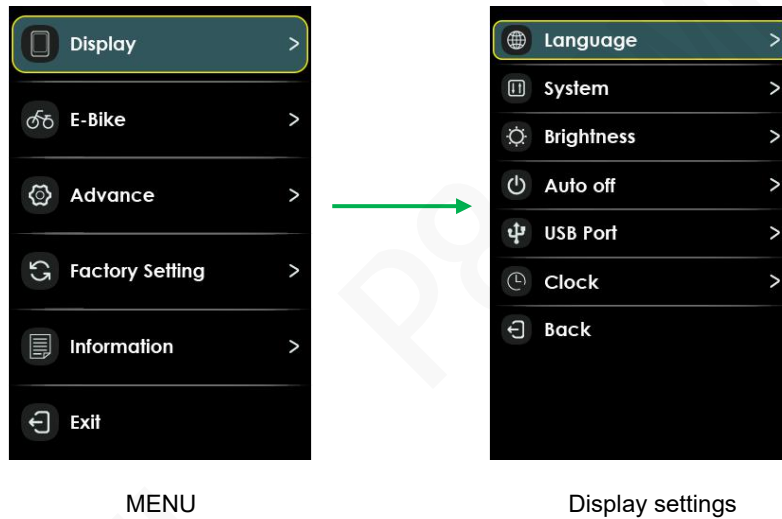

8.2.1 Language

5 languages are supported: English, Italian, Spanish, German, French. Default is English. Select language then click “Back” to confirm.

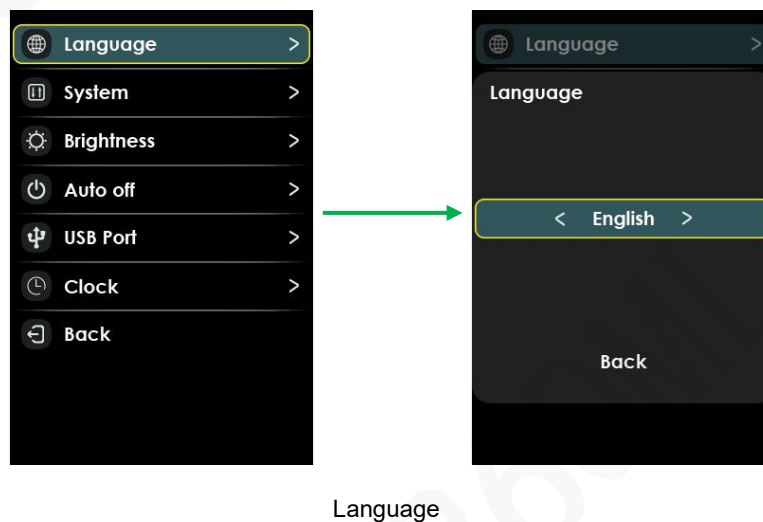

8.2.2 System

Select Metric and Imperial.

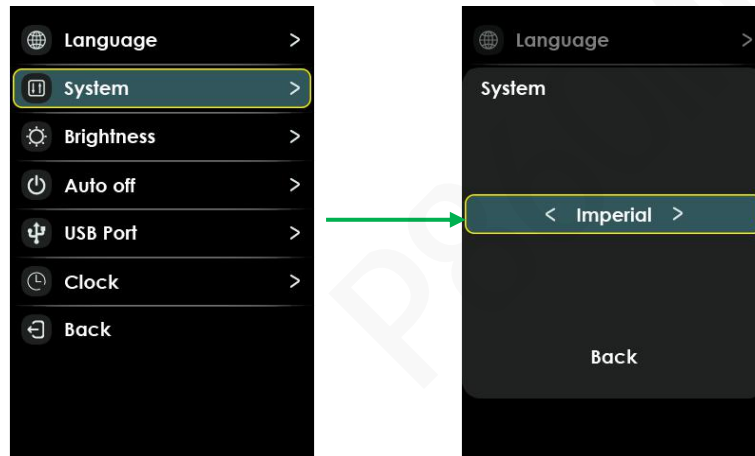

Metric and Imperial

8.2.3 Brightness

Press **UP/DOWN** button to change brightness of backlight, 1 is darkness, 5 is brightness.

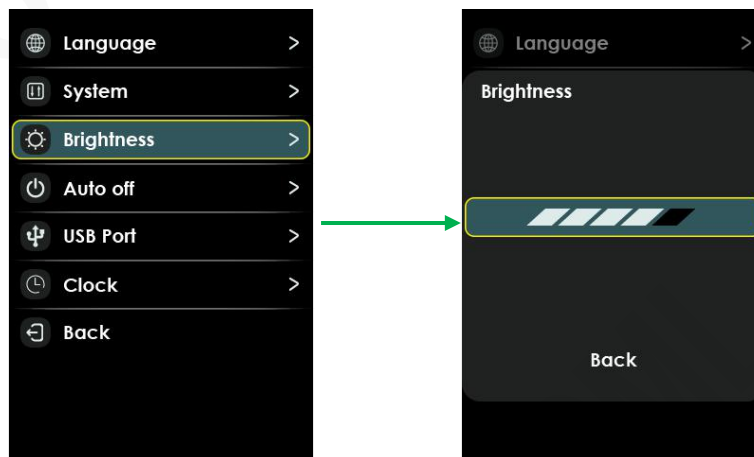

8.2.4 Auto off

This item enables to set the automatic shutdown time of the display, from 1 to 10min. Default value is 5 minutes, represents display shut down when there was no operation and riding for 5 minutes. OFF indicates that the display disables automatic shutdown.

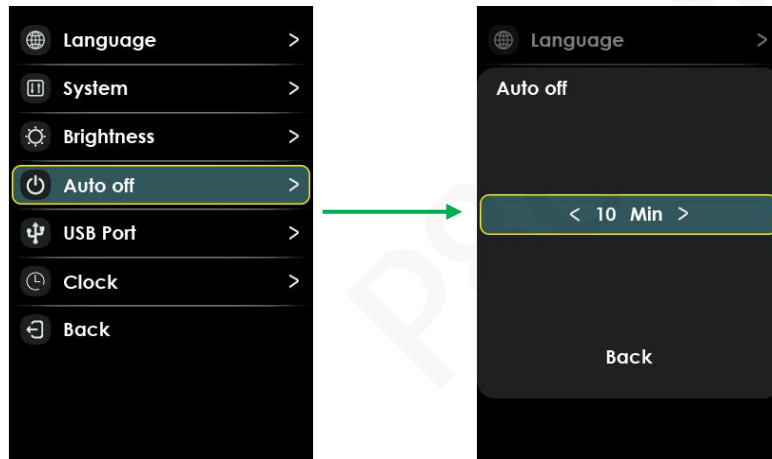

8.2.5 USB Port

You can set ON/OFF of USB port through **UP/DOWN** button.

USB port: Type-C, 5V/500Ma

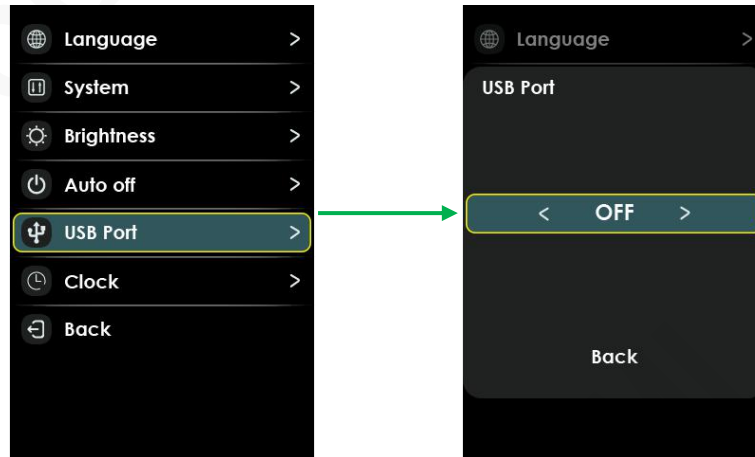

USB Port

8.2.6 Clock

This item set date and time. You can choose show or hide Clock on Main Page through **UP/DOWN** button.

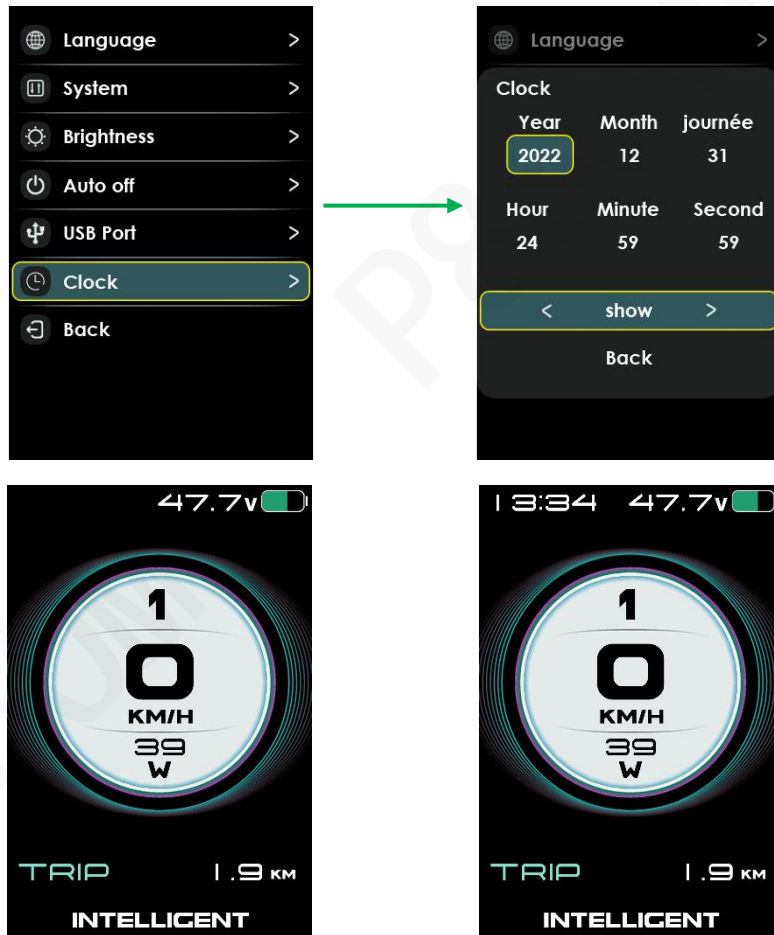

Hide

Show

* Note: When display was powered off, internal Button Battery can keep clock running. When display is power on, Button Battery will be charged by external battery. Clock may slow or stop if Button Battery is low, please charge the battery as follows: Set “Automatic shutdown” to “OFF” (Disable power off automatically), keep the display power on for 72 hours. Full charged Button Battery can keep clock running at least 3 months without charged.

8.2 E-bike Settings

E-bike settings include several items : Start password, Assist levels, Wheel, Battery, Battery Ind, Pow Ind, Light sensor.

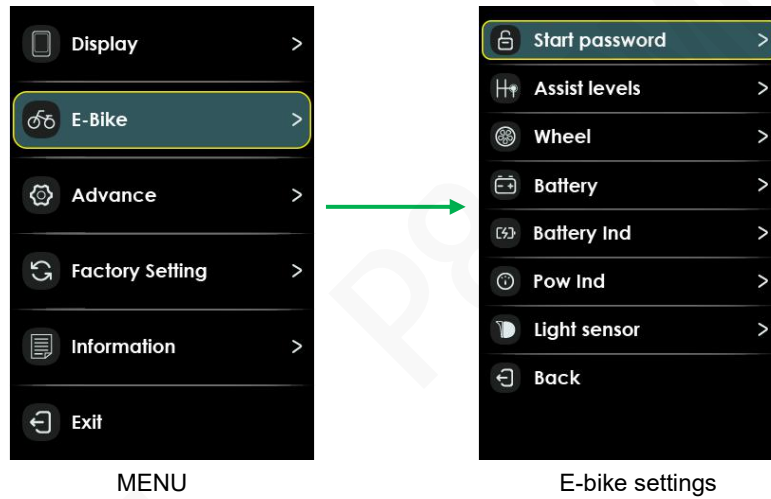

8.3.1 Start password

The start password includes two parameter settings, Start password、OFF/ON. If you had set start input **ON**, you must input right password before power on.

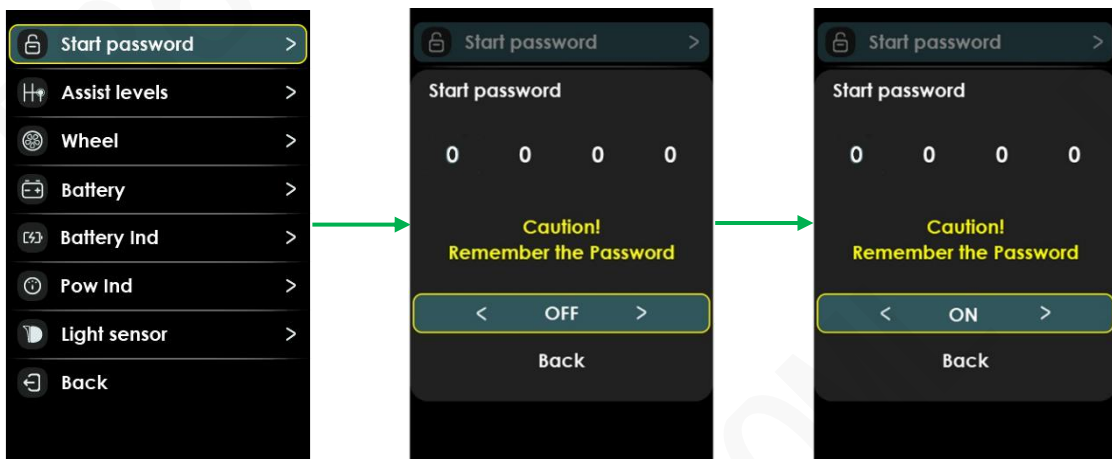

Turn on the start password function

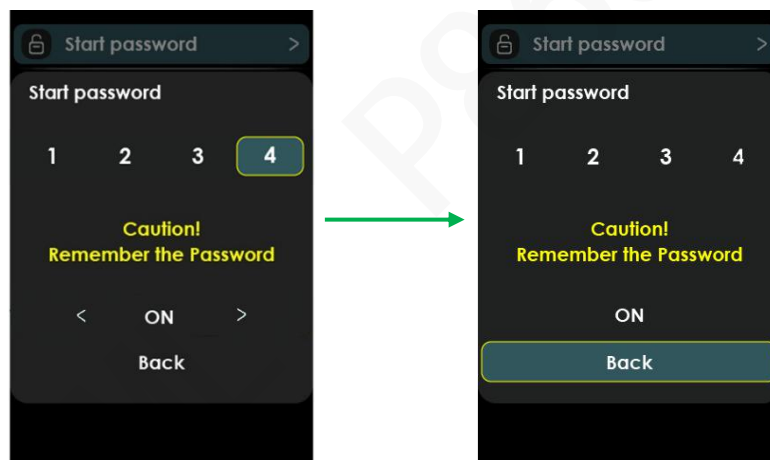

Start password setting page

You need to input the right password before start with 30 seconds.

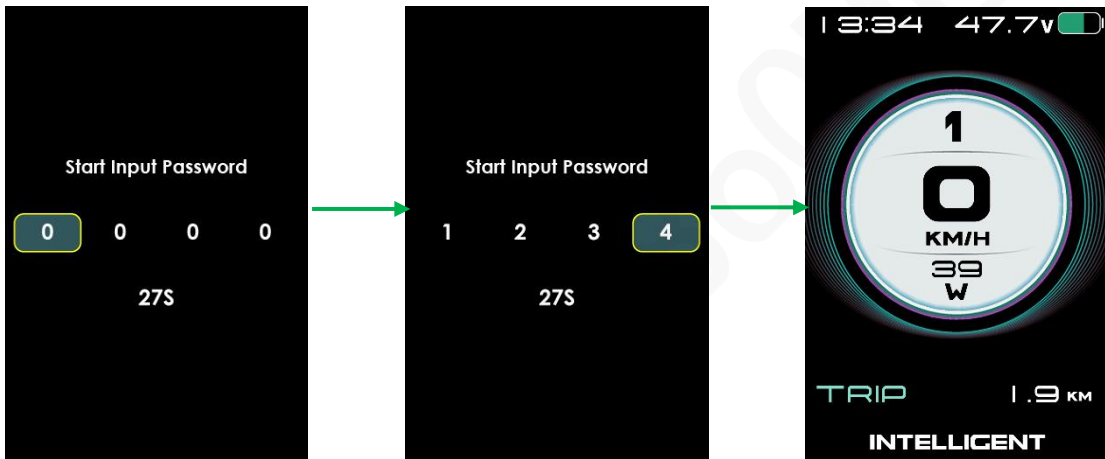

The boot page after setting the start password

* Display will power off automatically if the password was wrong. Press and hold the **POWER** button to shut down while entering the password.

* Display will power off automatically if the password was entered incorrectly 3 times.

8.3.2 Assist levels

This item can select assist levels, options are 3/5/9/UBE(6).

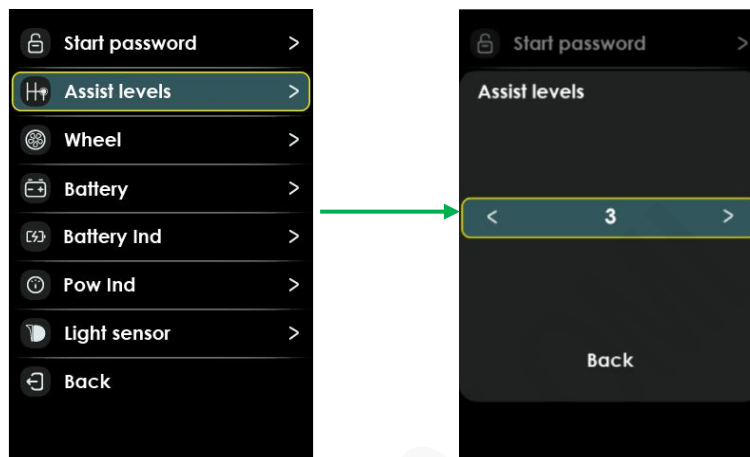

8.3.3 Wheel

This item can select wheel diameter, including 16/18/20/22/24/26/27/27.5/28/29 inch. Incorrect wheel diameter selection can lead to abnormal speeds.

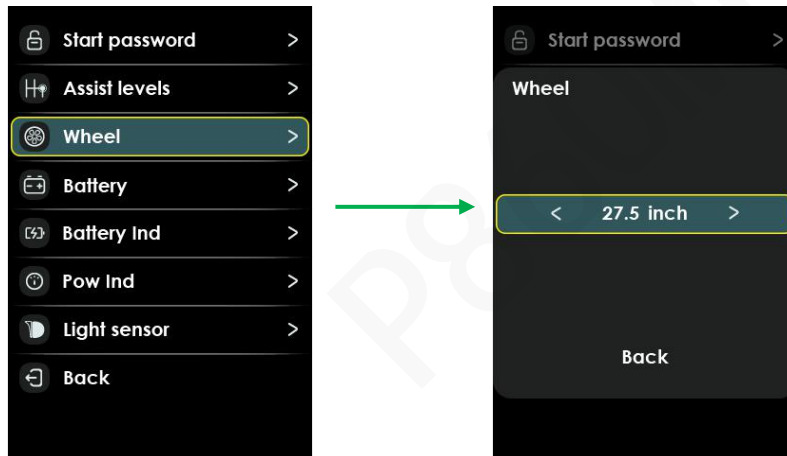

8.3.4 Battery

This item can select battery voltage setting, including 24/36/48/52V. This item is unused in Bafang system.

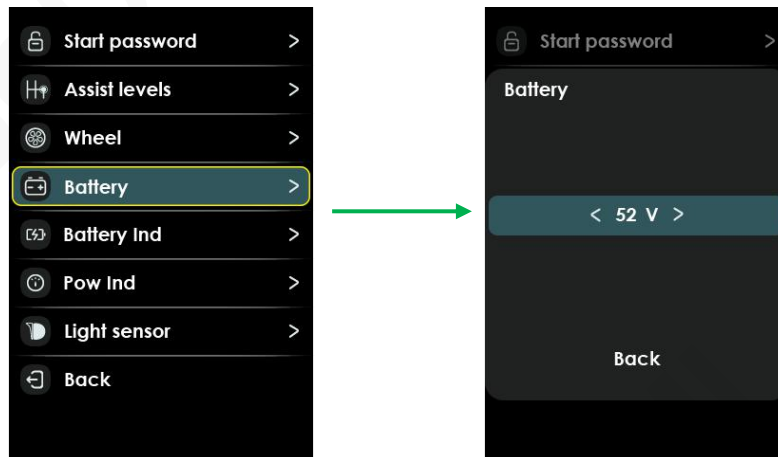

8.3.5 Battery Ind

This item can select battery Ind setting, including OFF/Percent/Voltage.

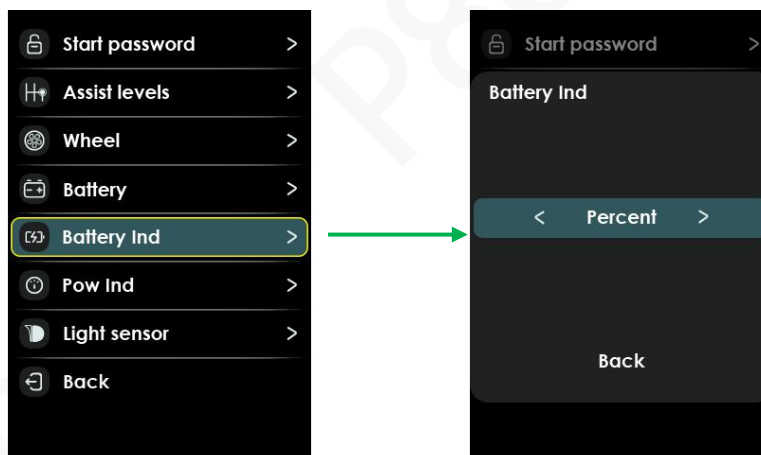

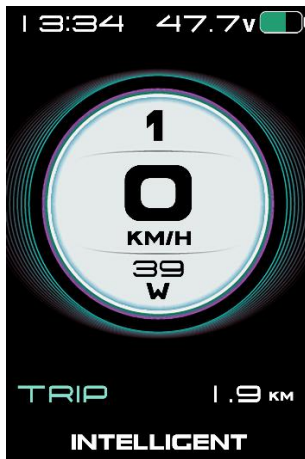

Voltage

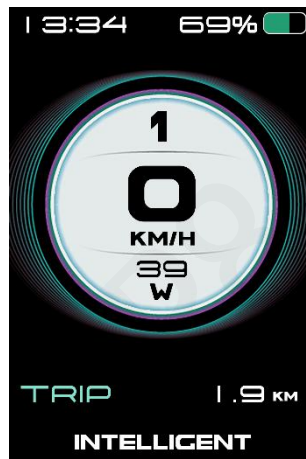

Percent

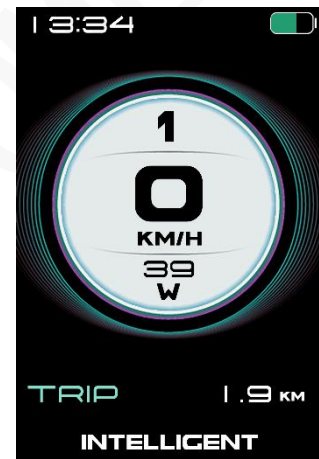

OFF

Note: The voltage is the remaining voltage or percentage of the battery.

8.3.6 Pow Ind

This item can select power indicator on Main Page, 'OFF', 'Output Power(W)' and 'Current(A)'.

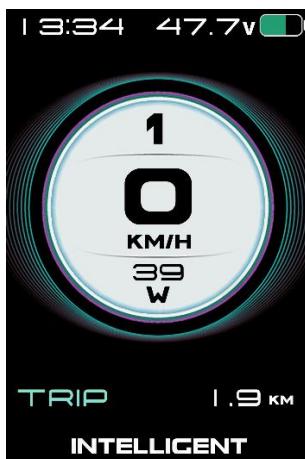
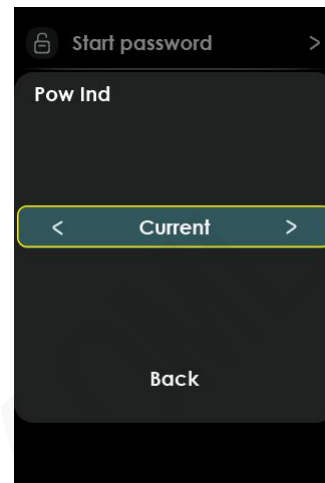
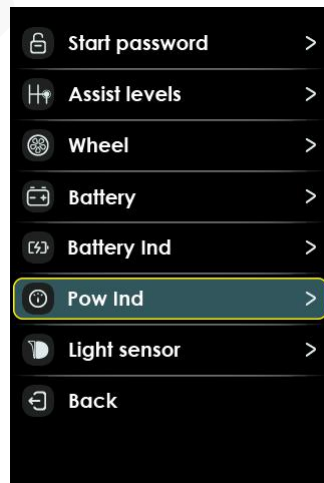

Output power (W)

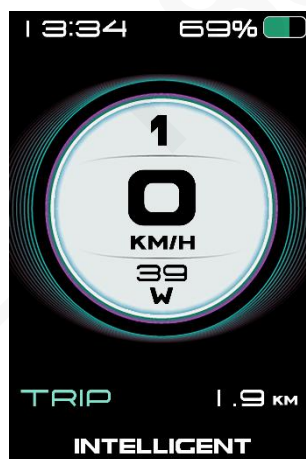

output current (A)

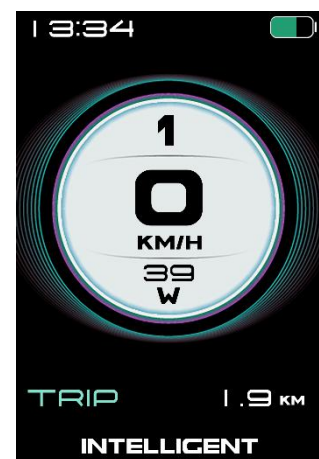

Power (OFF)

Note: Power indicator represent battery's output power (current), not motor.

8.3.7 Light sensor

This item can select Light sensor, High/Middle/Low/OFF.

Low: Represents that the sensor is activated in relatively dark light.

High: Represents that the sensor is activated in relatively bright light.

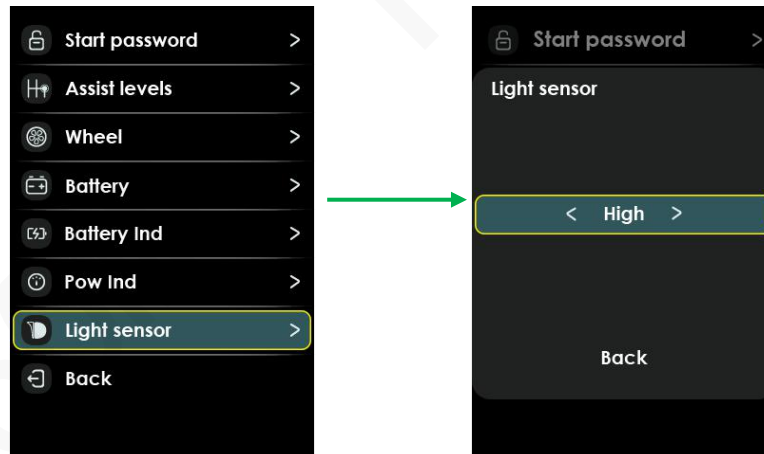

8.3 Advanced setting

Advanced settings have password to prevent illegal modification, default password is '1919', password may be different according to request.

Input correctly password to enter advanced setting page, where you can adjust the speed limit, range 10km/h ~ 60km/h、99m/h (6.2Mile/h ~ 37.3Mile/h、61.5 Mile/h).

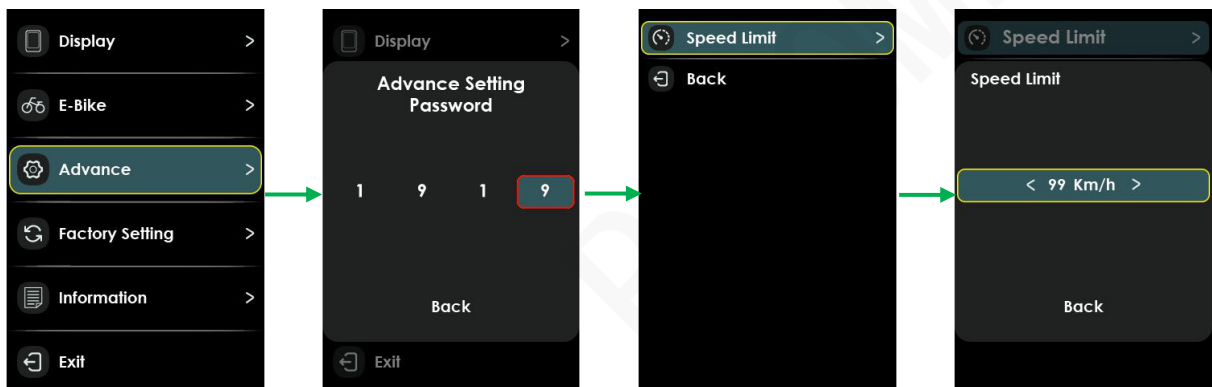

Note: The maximum speed is limited by the motor and controller, and it is not necessarily possible to reach the speed limit setting value.

8.4 Factory Setting

Select 'YES' will restore all setting to factory defaults.

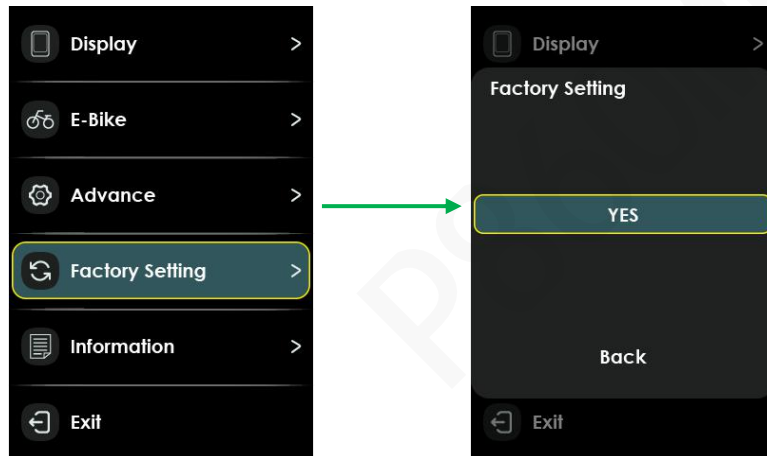

Note: ODO and CLOCK data are not cleared.

8.5 Information

The information display interface includes: Speed and Mileage Information, Product Information, Battery Information.

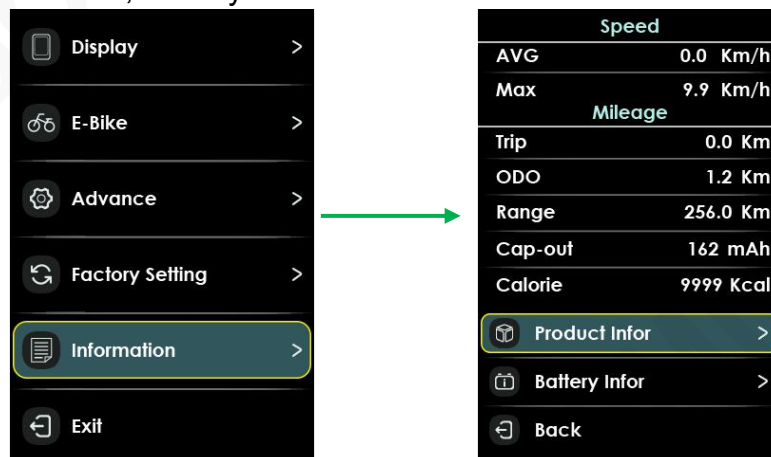

8.5.1 Product Information

Product Information show Hardware Version, Software Version, Date.

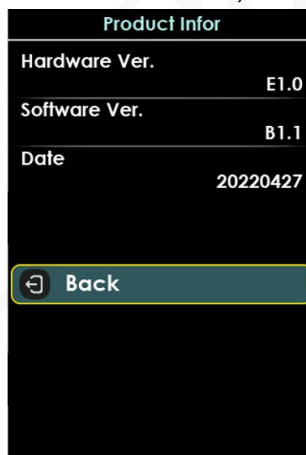

Product information

8.5.2 Battery Information

Battery Information can show voltage, Current, Capacity, Health, Cycle times, Remaining Capacity, Full Charge Capacity, Temperature, Max Un-charge Times, Last Un-charge Times.

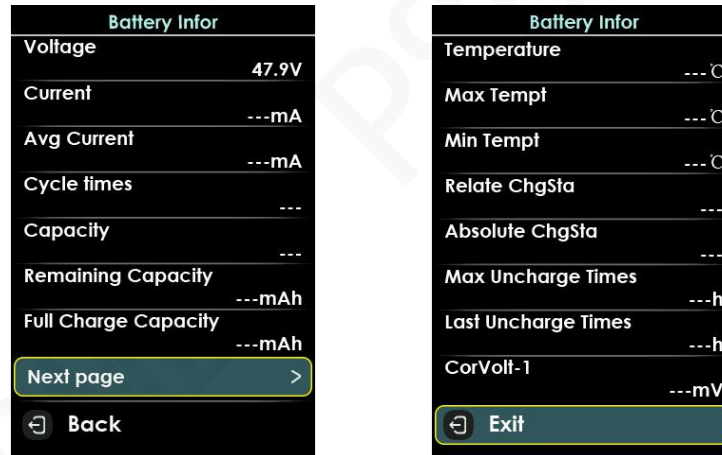

Battery Information

9. Errors code

Display shows error code and  at the bottom of the screen when system checked abnormal.

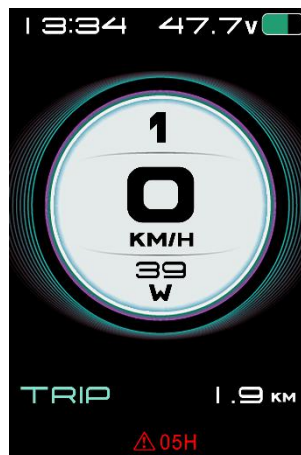

Error code prompt page

Error Code	Error description	Handle
04	Throttle error	Check throttle and connection
05	Throttle turn back fault	Check throttle and connection
07	Overvoltage protection	
08	Hall error	Check the hall connection
09	three-phase power error	Check three-phase power line connection
10	The controller is overheated	Stop using 10 minutes to restart
11	Motor overheating	Stop using 10 minutes to restart
12	Current sensor error	Check the sensor connection
13	battery temperature abnormality	Stop using 10 minutes to restart

14	Motor temperature sensor is abnormal	Check the sensor
15	Controller temperature sensor failure	Check the sensor
21	Speed sensor fault	Check the sensor
22	BMS Communication Error	Check the cable connection
23	Headlight error	Check the cable connection
24	Headlight sensor error	Check the cable connection
25	Torque sensor signal error	Contact the supplier
26	Torque sensor speed error	Contact the supplier
30	Communication Error	Check the cable connection

10. Assembly instructions

Please pay attention to the torque value, exceeding the maximum torque can damage the part.

Electrical or pneumatic tools is not recommended.

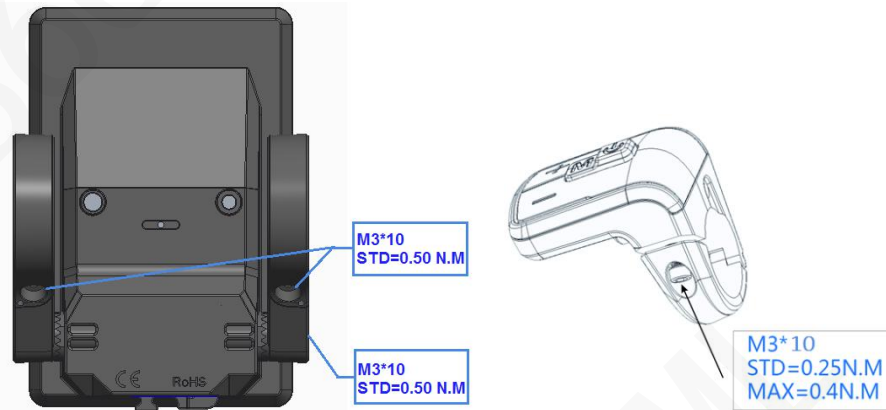

There are 3 pairs of rubber ring to match different handlebars, choose matched rings for assembly.

11. Install and use precautions

Do not adjust viewing angle before loose the screws.

